

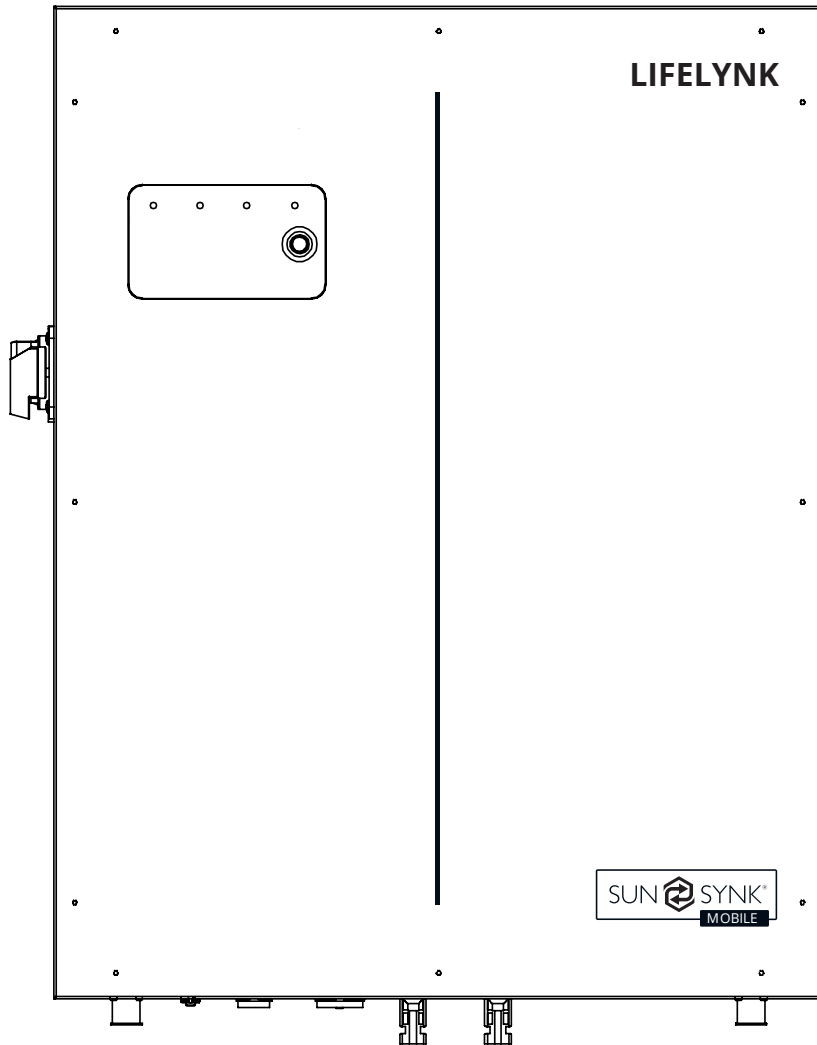

SM3.6kWLL



USER MANUAL UK

www.sunsynkmobile.com / sales@sunsynkmobile.com



Index

1.	Safety	4
1.1.	General Safety Information	4
1.2.	Symbols in the Manual	4
1.3	Symbols in the Product	5
1.4.	Safety Instructions	6
1.5.	Disposal	6
2.	Product Introduction	7
3.	Box Contents	8
4.	Technical Specification	8
5.	Installation	10
5.1.	Selecting the Mounting Area	10
5.2.	Mounting the Inverter	11
5.3.	Turning on the Batteries	12
5.4.	Flow Diagram	13
5.5.	Connecting to the Mains / Grid	13
5.6.	Wiring the PV Panels	13
5.7.	CT Coil and Load Power Settings	14
5.8.	Parallel Operation	16
5.9	External Battery and Parallel Connections	17
6.	LCD Display Screen	19
7.	Factory Settings	20





8.	Operation	21
8.1.	System Flow	22
8.2.	Switching On / Off	22
8.3.	Home Screen	22
8.4.	Home Settings	23
8.5.	Basic Settings	23
8.6.	Work Mode Settings	24
8.7.	System Logger	25
8.8.	Advance Settings	26
8.8.1.	Grid Settings	27
8.8.2.	Battery Settings	27
8.8.3.	System Settings	28
8.8.4.	Export Control	29
8.8.5.	Charge From Main	29
8.8.6.	Earth Neutral Bond	29
8.8.7.	Night Power Saving	30
8.10.	Settings Details	31
8.11.	Fault Codes	34
9.	Commissioning	36
9.1.	Start Up / Shutdown Procedure	36
9.2.	Information for Commissioning the Inverter	36
9.3.	GFDI Fault	38
10.	Maintenance	38
	Appendix A	38

1. SAFETY











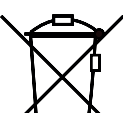

1.1. General Safety Information

- This device should only be used in accordance with the instructions within this manual and in compliance with local, regional and national laws and regulations. Only allow this device to be installed, operated, maintained or repaired by other person(s) who have also read and understood this manual. Ensure the manual is included with this device should it be passed to a third party.
- **DO NOT** allow minors, untrained personnel, or person(s) suffering from a physical or mental impairment that would affect their ability to follow this manual, install, maintain or repair this device.
- Any untrained personnel who might get near this device while it is in operation **MUST** be informed that it is dangerous and instructed carefully on how to avoid injury.

1.2. Symbols in the Manual

 WARNING	This symbol indicates information that if ignored, could result in personal injury or even death due to incorrect handling.
 CAUTION	This symbol indicates information that if ignored, could result in personal injury or physical damage due to incorrect handling.
PLEASE NOTE	Indicates information that is considered important, but not hazard-related.
	This symbol indicates that for paralleling, only batteries with the model number NBYS51.2V75AH can be used.
 MC4	This symbol indicates that voltage must be equal across MC4 connections.

1.3. Symbols in the Product

	Caution, risk of electric shock.
	Caution, risk of burn.
	Be careful when touching the inverter! It is an electrical product with risk of electric shock and heating.
	Indicates that this product is recyclable.
	Indicates that the device, accessories and packaging must not be disposed of as unsorted municipal waste and must be collected separately at the end of the usage. Please follow Local Ordinances or Regulations for disposal or contact an authorized manufacturer representative for information concerning the decommissioning of equipment.
	CE mark is attached to the solar inverter to verify that the unit follows the provisions of the European Low Voltage and EMC Directives.
	Refer to the operating instructions.
	The UKCA marking is used for products placed on the market in Great Britain (England, Scotland and Wales). The UKCA marking applies to most products for which the CE marking could be used.
	The batteries contained in this product have an explosive, self-reactive substance that may explode when heated.
	Keep the product out of reach of children!
	Keep away from open flames and moisture, and store below 60 °C (140 °F).
	Avoid unsuitable shoes for installing and operating the inverter.

1.4. Safety Instructions



WARNING

HIGH LIFE RISK DUE TO FIRE OR ELECTROCUTION.

The Lifelynk X can only be installed by a qualified licensed electrical contractor. This is not a DIY product.

Ensure to follow the safety warnings listed below:

- Be sure to read this manual thoroughly before installation.
- Do not attempt to install the inverter by yourself. Installation work must be carried out in compliance with national wiring standards and by suitably qualified personnel only.
- Do not turn on the power until all installation work is complete.
- Do not disassemble the inverter. If you need to repair or maintenance, contact a professional service centre.
- Always use an individual power supply line protected by a circuit breaker and operating on all wires with a distance between contacts of at least 3mm for this unit.
- The unit must be correctly grounded and the supply line must be equipped with a suitable breaker and RCD to protect people.
- Disconnect all wires before performing any maintenance or cleaning to reduce the risk of electric shock.
- The unit is not explosion-proof, so it should not be installed in an explosive atmosphere.
- Never touch electrical components immediately after the power supply has been turned off since the system can still have residual energy, so electric shock may occur. Therefore, after turning off the power, always wait 5 minutes before touching electrical components.
- This unit contains no user-serviceable parts. Always consult an authorised contractor for repairs.

1.5. Disposal

DO NOT dispose of this product with domestic waste!

Electrical devices should be disposed of in accordance with regional directives on electronic and / or electronic-waste disposal. In case of further questions, please consult your supplier. In some cases, the supplier can take care of disposal.

2. PRODUCT INTRODUCTION

The Lifelynk X is a highly efficient power management tool that allows the user to hit those 'parity' targets by managing power-flow from multiple sources such as solar, mains power (grid) and generators, and then effectively storing and releasing power as and when utilities require.

INTERACTIVE

- Easy and simple to understand LCD display.
- Supporting Wi-Fi or GSM monitoring.
- Built-in MPPT trackers.
- Smart settable 3-stage MPPT charging for optimised battery performance.

COMPATIBLE

- Compatible with main electrical grid voltages.
- 230V single-phase, pure sine wave inverter.

CONFIGURABLE

- Fully programmable controller.
- Programmable supply priority for battery or grid.
- Programmable multiple operation modes: on-grid / off-grid & UPS.
- Configurable battery charging - current / voltage based on the application.

SECURE

- Overload / over-temperature / short-circuit protection.
- Smart battery charger design for optimized battery protection.
- Limiting function installed to prevent excess power overflow to grid.

APPLICATIONS

- Power shedding (home / office / factory).
- UPS (Uninterrupted Power Supply).
- Remote locations with solar.
- Building sites.
- Telecommunication.

3. BOX CONTENTS

This box contains:

Lifelynk X (main unit)	Wall mounting bracket
Screw pack	Data logger (Sunsynk Wi-Fi)
CT Coil (2 pin AERO type female connector)	3m cable
2 x MC4 connectors	1x3 pin AC Load connector (female) and 1x3 pin AC Grid connector (male)

4. TECHNICAL SPECIFICATION

- Pure sine wave inverter with a maximum input power of 4.5kW.
- High nominal output power of 3.6 kW that can run several appliances.
- With batteries, the power capacity is 3840Wh.
- MPPT charge controller feature.
- Bi-directional inverter that can rapidly charge its internal batteries in just one hour.

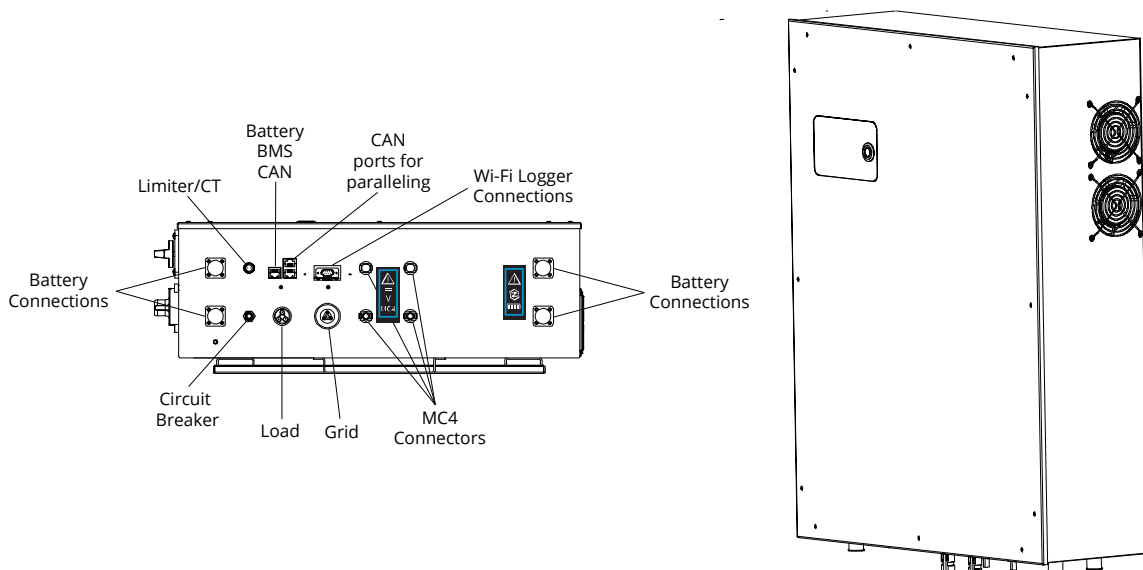
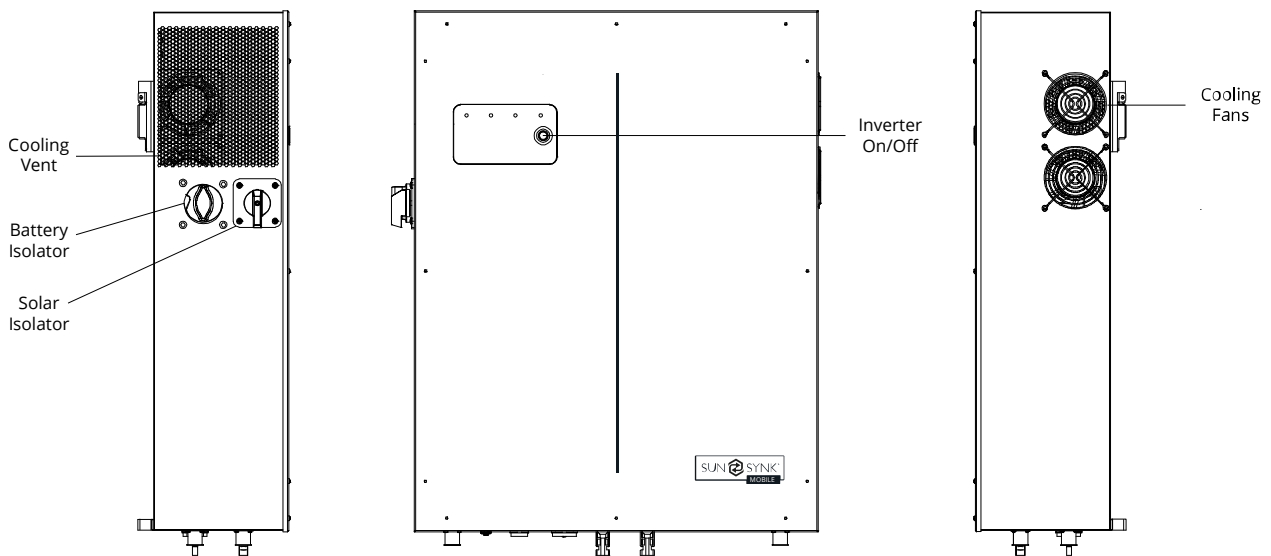

Model	Lifelynk X
PV Input Data	
Max. PV Power	4500W
Max. PV Input Voltage	500V
MPPT Voltage Range	120-450V
Start-up Voltage	150V
Max. PV Current	12A (total current of the two MC4 sets combined)
AC Output / Input Data	
Maximum Input Power	3600W
Nominal Input / Output Power	3600W
Max. Input / Output Apparent Power	3600VA
Nominal Voltage	230VAC
Max. Input / Output Current	16A
Max. Bypass Current	40A
Nominal Frequency	50Hz
Power Factor Range	0.8 Leading ~ 0.8 Lagging
Standalone Data	
Nominal Output Power	3600W
Nominal Output AC Voltage	230VAC (Configurable)
Nominal Output AC Frequency	50Hz (Configurable)
Output THD (Resistor load)	<3%
Battery Data	
Battery Voltage Range	40V~58V
Max. Charging Current / Discharging Current	60A/80A
Battery Type	LiFePO4
Power of Each Battery	3840Wh
Number of Batteries	1 (Installed)
Ingress Protection	IP20
Protective Class	Class I
Efficiency	
Max. Efficiency	97.6%
Max. Battery to Load Efficiency	94.0%
Europe Efficiency	97.0%
MPPT Efficiency	99.9%
Operating Temperature Ranges	
Inverter	-25°C ~ +60°C
Battery Charging	0°C ~ +45°C
Battery Discharging	-20°C ~ +50°C

5. INSTALLATION

5.1. Selecting the Mounting Area

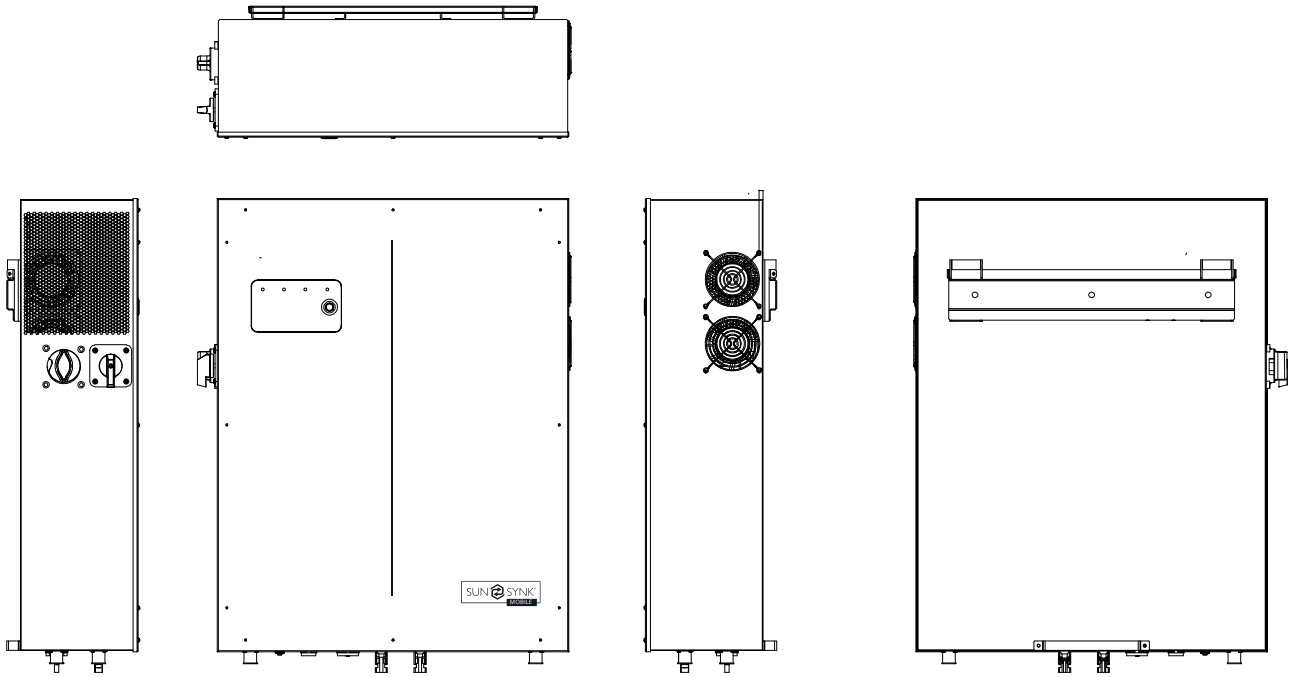

DO NOT install in the following areas:

- Areas with high salt content, such as the marine environment. It will deteriorate the metal parts and possibly lead to water / dampness penetrating the unit.
- Areas filled with mineral oil or containing splashed oil or steam such as in kitchens. This will deteriorate plastic parts of the unit, causing those parts to fail or allow water /damp to penetrate the unit.
- Areas that generate substances that adversely affect the equipment, such as sulphuric gas, chlorine gas, acid, or alkali. These can cause the copper pipes and brazed joints to corrode and fail to conduct electricity reliably.
- Areas that can cause combustible gas to leak, which contains suspended carbon-fibre, flammable dust or volatile inflammability such as paint thinner or gasoline.
- Areas where there may be gas leaks and where gas may settle around the unit, as this is a fire risk.
- Areas where animals may urinate on the unit or ammonia may be generated.
- High altitude areas (over 4000 metres above sea level).
- Environments where precipitation or humidity are above 95%.
- Areas where the air circulation is too low.

ALSO CONSIDER:

- Installing the indoor unit, outdoor unit, power supply cable, transmission cable and remote control cable at least 1 metre away from any television or radio receiver. This will prevent TV reception interference or radio noise. This will also prevent radio signal interference from external units that might interfere with the Wi-Fi or GSM monitoring.
- If children may approach the unit, take preventive measures so that they cannot reach and touch the unit.
- Install the indoor unit on the wall where the height from the floor is higher than 1600mm.
- For proper heat dissipation, allow a clearance of approximately 500mm to the side, 500mm above and below the unit and 1000mm to the front of the unit.

5.2. Mounting the Inverter

- Select a location that provides adequate support for the weight of the inverter.
- Install this inverter so that the LCD screen is eye-level for easy operation.
- An appropriate ambient temperature lies between $-20 \sim 60^{\circ}\text{C}$ for optimal operation. Battery charging temperature range lies between $0^{\circ}\text{C} \sim 45^{\circ}\text{C}$.
- Ensure other objects and surfaces are outside of the recommended spaces (500mm each side / above and below / front) to guarantee heat dissipation and easy access to the wiring / cabling.

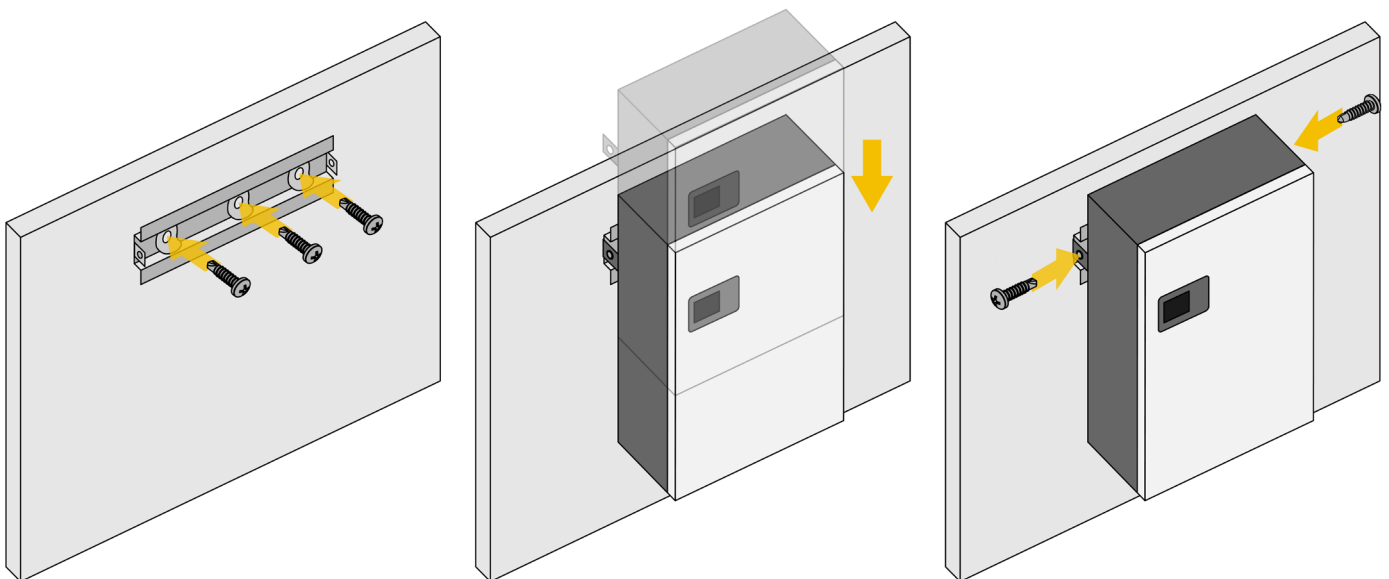



CAUTION

Risk of Injury (Heavy Object)

Remember that this inverter is heavy, so users must be careful in handling the unit during installation especially when mounting or removing from a wall.

5.3. Turning on the Batteries

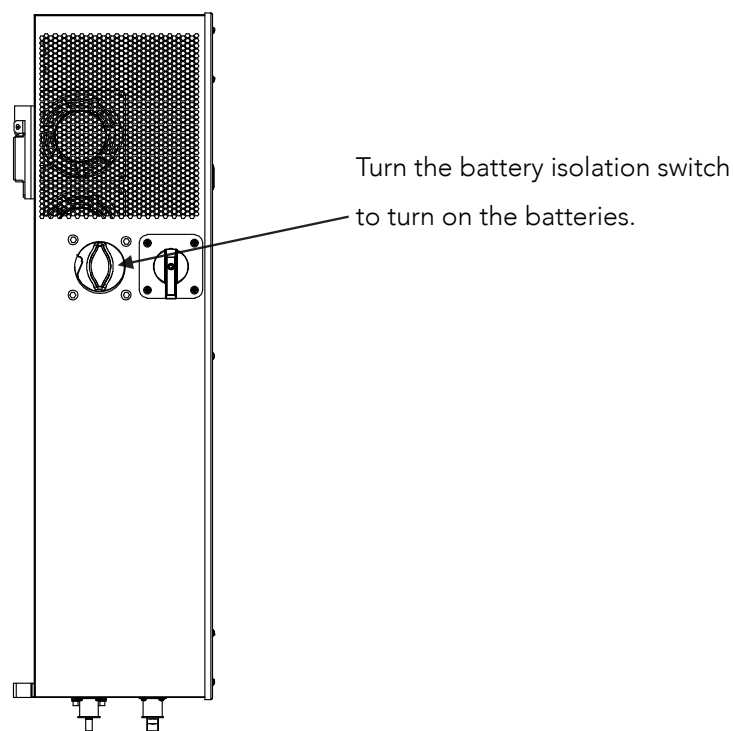

CAUTION

Setting a power limit higher than maximum will damage the battery fuse.

5.4. Flow Diagram

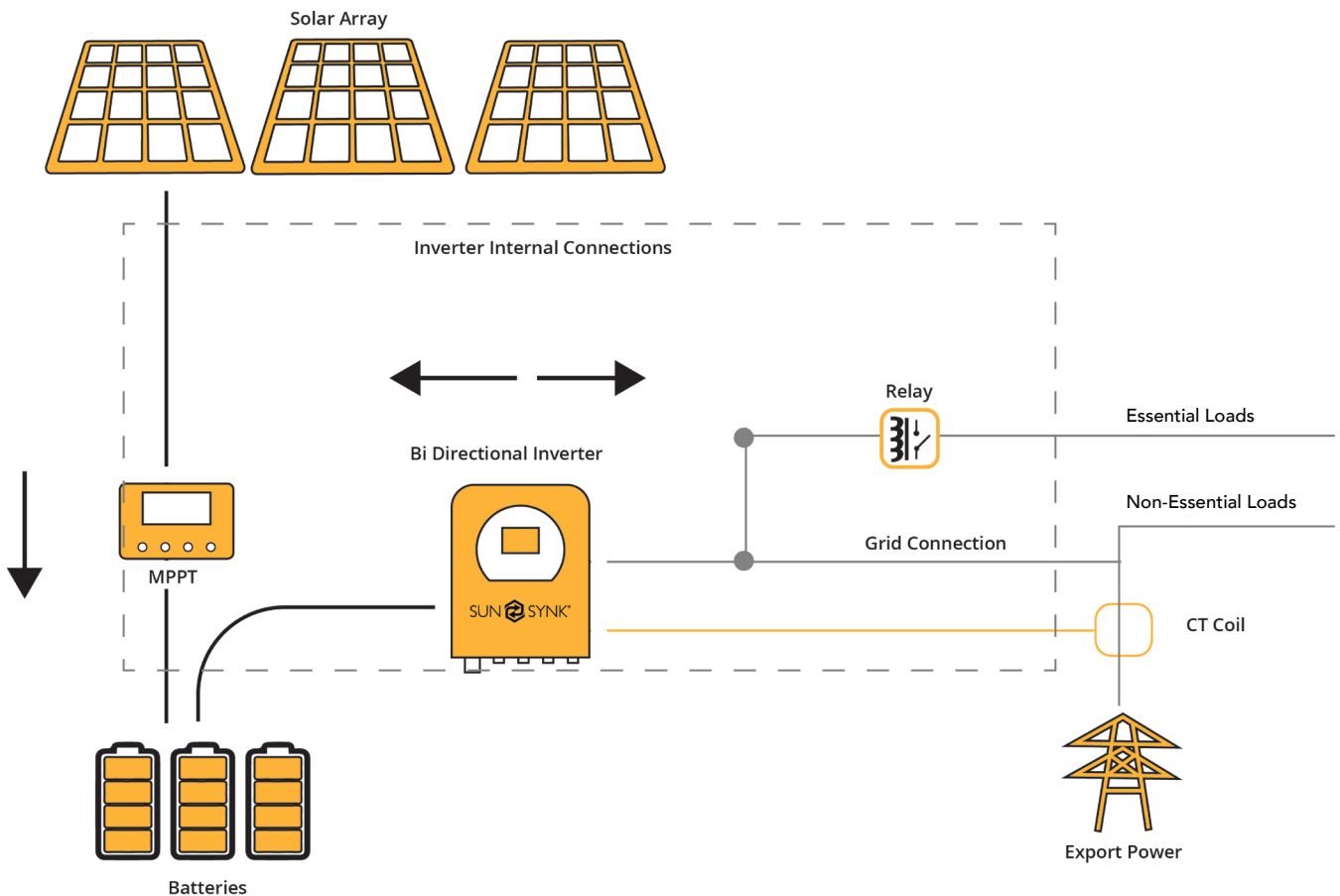

5.5. Connecting to the Mains / Grid

1. Connect the Lifelynk X Hybrid Inverter to the electrical grid via the *grid ports*, using a suitable RCD and a 20A fuse on the consumer board.
2. Now, using a 3mm cable, connect only the essential loads to the *load ports* (output) to a secondary consumer board, considering the maximum limit of 3.6 kW.
3. Ensure the main consumer unit and the secondary consumer unit are correctly grounded to the Lifelynk X.

5.6. Wiring the PV Panels

- The Lifelynk X Hybrid Inverter has an MPPT controller with a maximum input current of 12A.
- Please do not connect two PV sets with different voltages to the MC4 connectors. This can damage the PV set, causing the system to malfunction.
- Before connecting to PV modules, install a separate DC circuit breaker between the inverter and PV array.
- To avoid any malfunction, **DO NOT** connect any PV modules with possible current leakage to the inverter. For example, grounded PV modules will cause current leakage to the inverter.
- Also, the open-circuit voltage (Voc) of the PV modules does not exceed the maximum input voltage of the inverter. Also, the Voc of the PV array should be higher than the minimum starting voltage of the inverter.
- Connect the PV panels into the MC4 connectors.

5.7. CT Coil and Load Power Settings

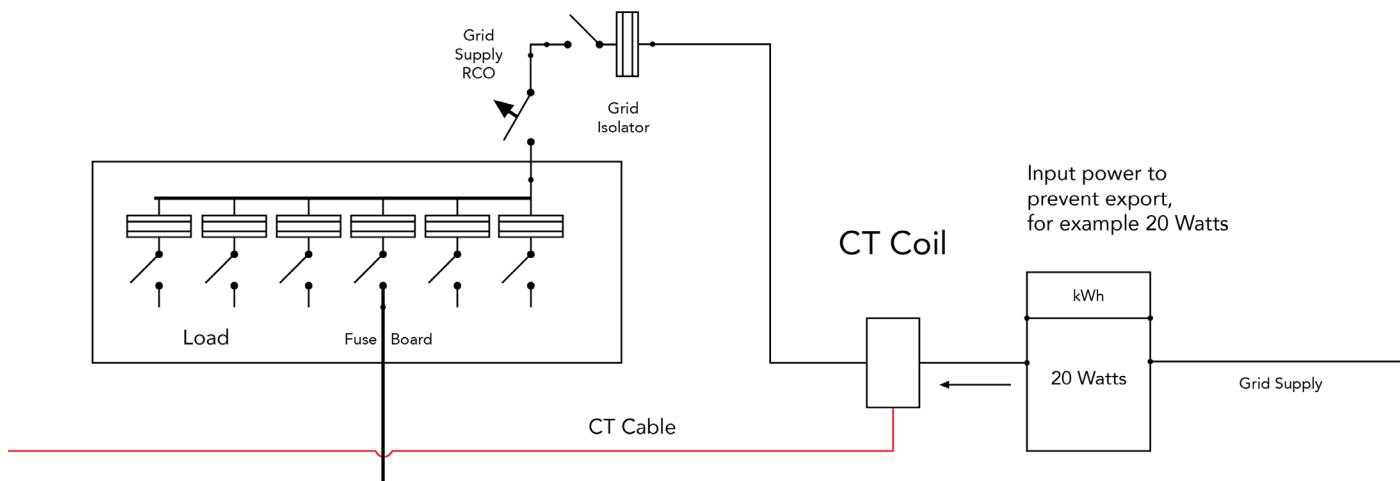

The CT coil is one of the most important parts of the Lifelynk X. This device reduces the power of the inverter to prevent feeding power to the grid. This is also known as zero export.

- Fit the coil (sensor) around the live cable on the main fuse feeding the building and run the cable back to the inverter. This cable can be extended up to an extra 10m using a similar cable.
- Connect the other end of the CT coil into the inverter terminals marked as *CT coil*.

Fit around positive cable feeding the building BETWEEN the meter and main fuse.

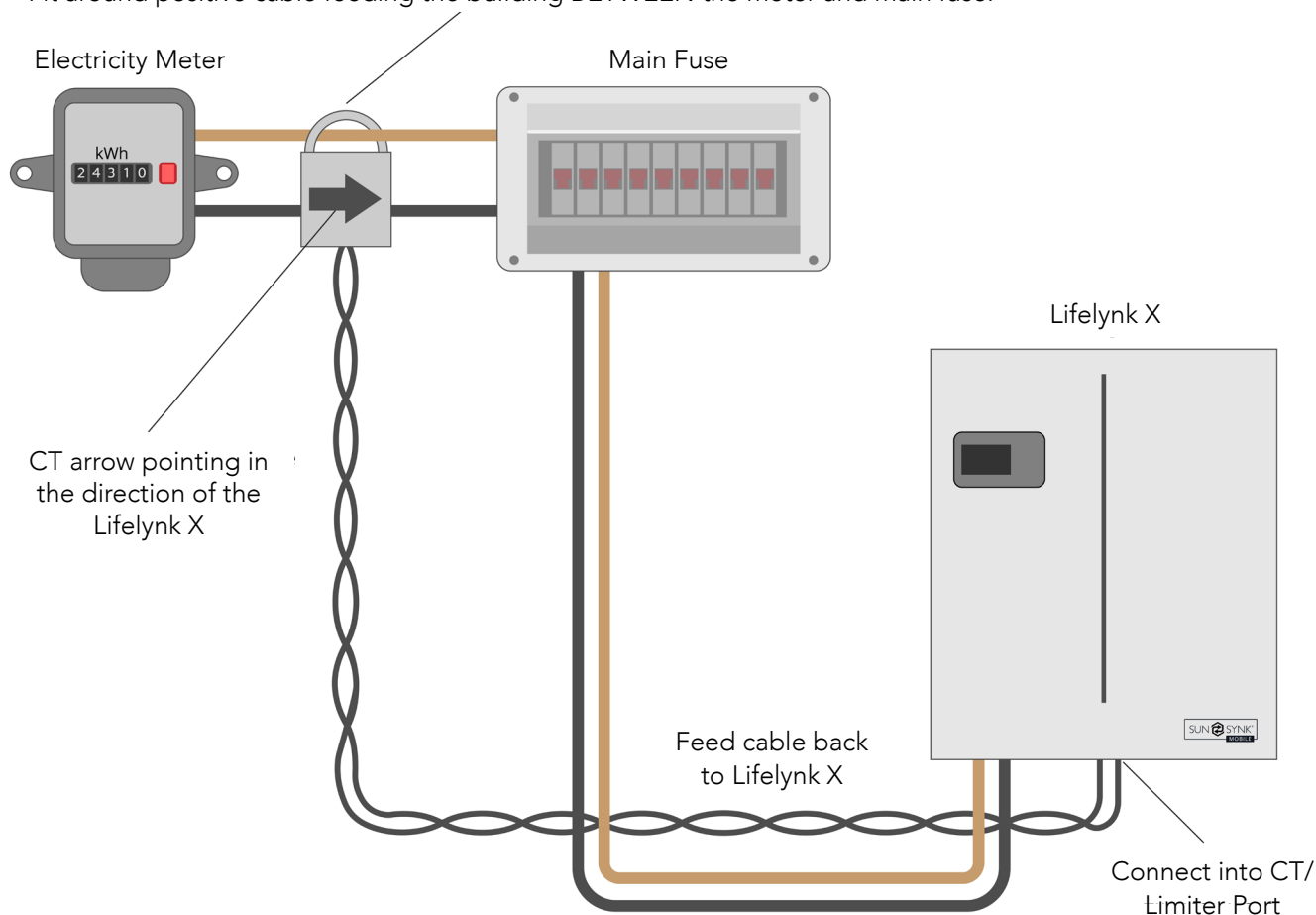

You can access the *CT Coil Screen* directly from the *Home Screen* by pressing the Home/Back button:

SUN  SYNK	
CT Power	Load Power
0W	0W
Work Mode: Standalone Input Trickle Feed: 30W Export Control: Zero Export Earth Neutral Bond: Enable Night Power Saving: Enable	

You can access the *Internal Battery Pack* page by pressing the Home/Back button again:

SUN  SYNK	
Internal Battery Pack	
Capacity: 75Ah	SOC: 64%
Voltage: 53.2V	Current: 32A
Charge Voltage Limit: 57.6V	
Discharge Voltage Limit: 45.0V	
Charge Current Limit: 37A	
Discharge Current Limit: 75A	
Temp: 34.8°C	Alarm: 0x0000

You can access the *External Battery Pack* page by pressing the Home/Back button again:

SN: xxxxxxxxxxxx	
SUN  SYNK	
External Battery Pack	
Capacity: 75Ah	SOC: 65%
Voltage: 53.4V	Current: 30A
Charge Voltage Limit: 57.6V	
Discharge Voltage Limit: 45.0V	
Charge Current Limit: 37A	
Discharge Current Limit: 75A	
Temp: 31.2°C	Alarm: 0x0000

5.8. Parallel Operation

In order to connect Lifelynk inverters to operate in parallel, you need to set up the work mode configuration for each the inverter. Basically, you have to set which inverter will be the master and which will be the slaves, and then make the connections described in section 5.9 (External Battery and Parallel Connections).

Basic Settings	
Set Time	15:16
Set Date	19-05-2023
Backlight	On
Work Mode	Master
SOC/Voltage	Voltage
Factory Reset	No

Basic Settings	
Set Time	15:16
Set Date	19-05-2023
Backlight	On
Work Mode	Slave 02
SOC/Voltage	Voltage
Factory Reset	No



WARNING

To ensure the proper functioning of the parallel operation, it is important first to establish the work mode for both the Master and Slave inverters and then make the necessary wiring connections.

If you make the connection prior to changing the work mode, an F15 error will be displayed on the Fault Codes page. In the event of this error, please maintain the connection and proceed to the settings to modify the work mode as presented above, and wait approximately 3-4 minutes. After that, the device should return to its normal working condition, with the error cleared.

5.9. External Battery and Parallel Connections

Inverter Unit: 1 External Battery Number: 1

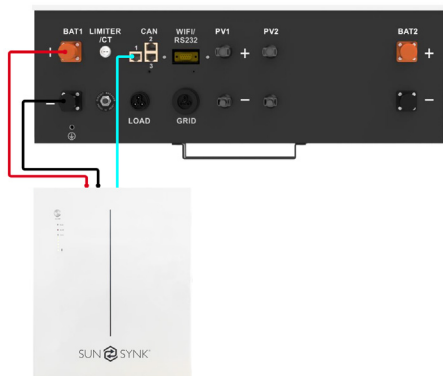

Inverter Unit: 1 External Battery Number: 2

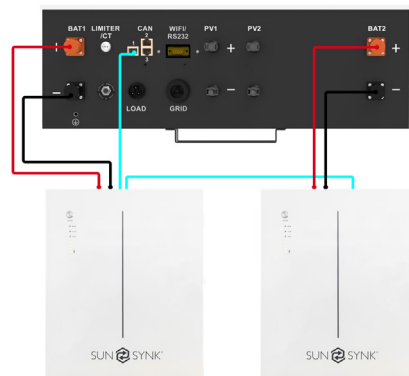

Inverter Unit: 2 External Battery Number: 1

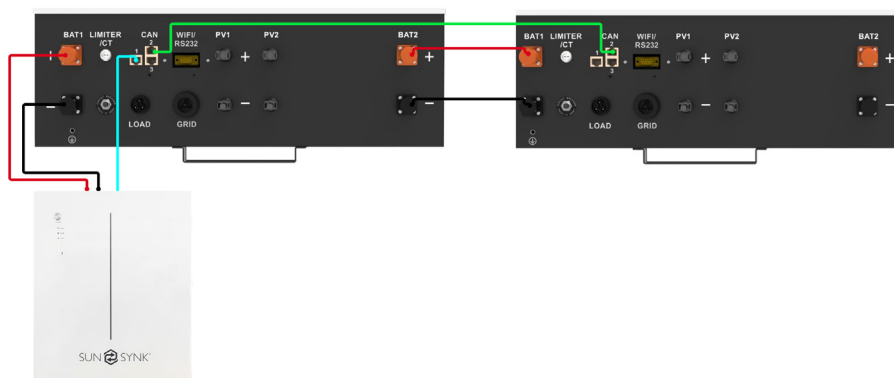

Inverter Unit: 2 External Battery Number: 2

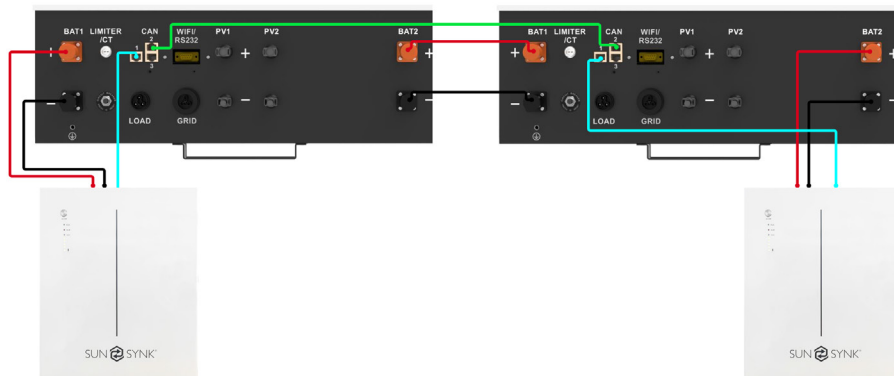

Inverter Unit: 3 External Battery Number: 1



Inverter Unit: 3 External Battery Number: 2

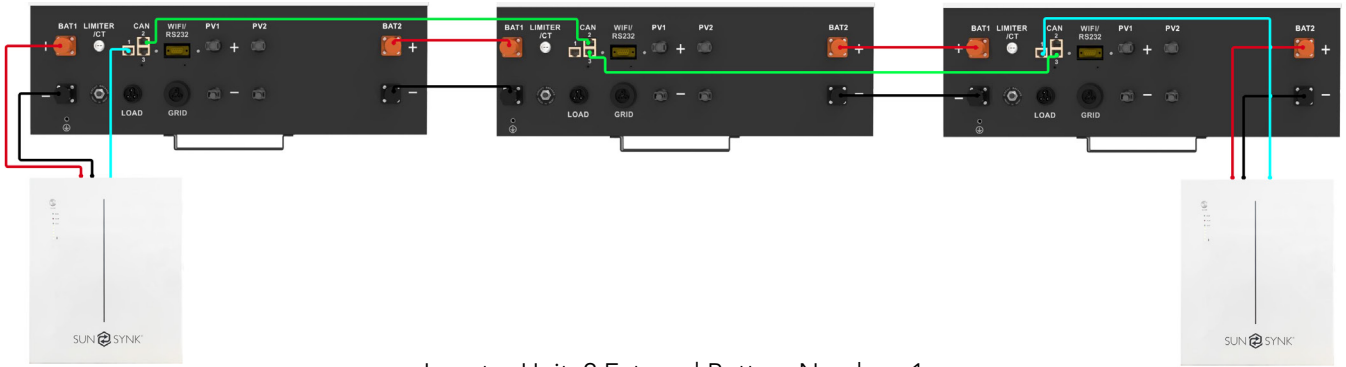

Inverter Unit: 2 External Battery Number: 1
(Shows CT Coil Connection + Master&Slave)

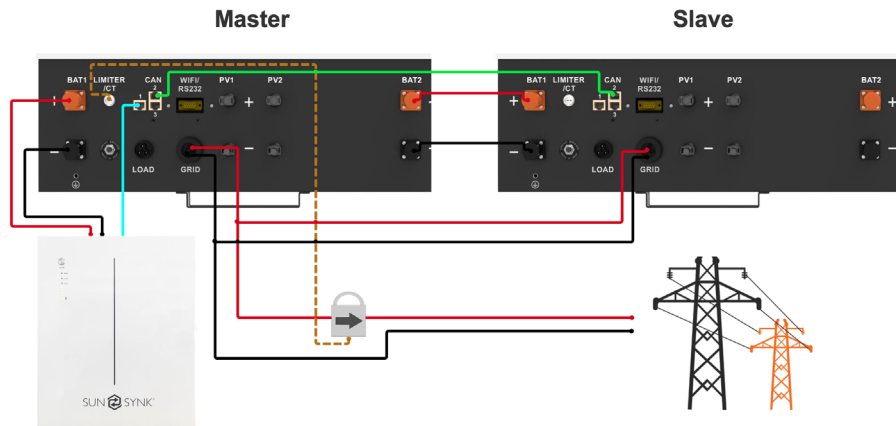

Inverter Unit: 2 External Battery Number: 2
(Shows Batteris connected in parallel)

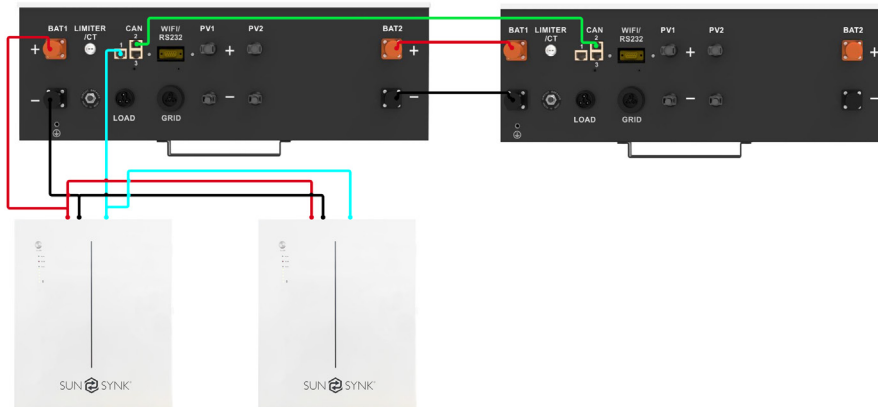

Inverter Unit: 3 External Battery Number: 6
(Show External Batteries can be installed into each inverter)

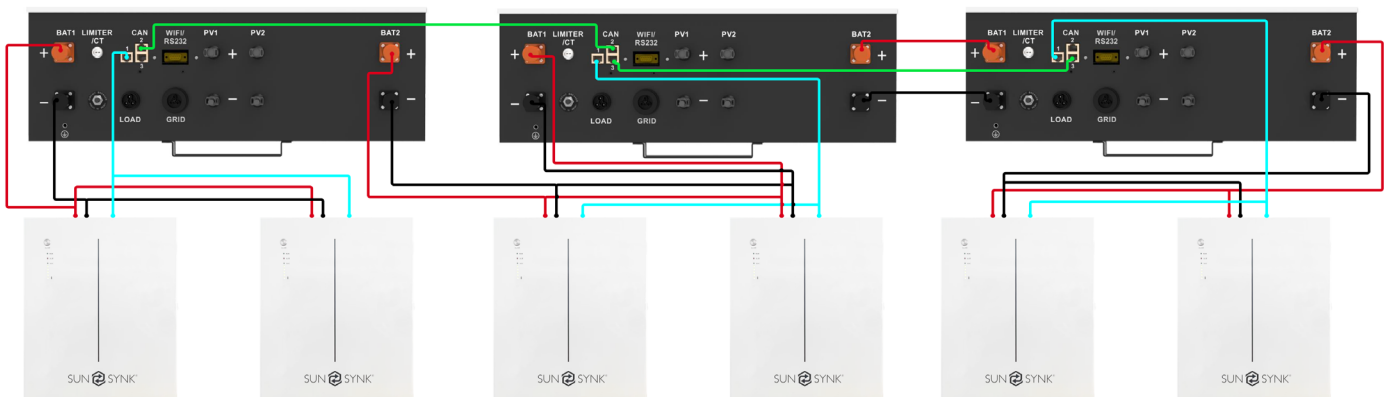

6. LCD DISPLAY SCREEN

The LCD display screen is situated on the front of the Lifelynk X, this is where you can control and operate the system.

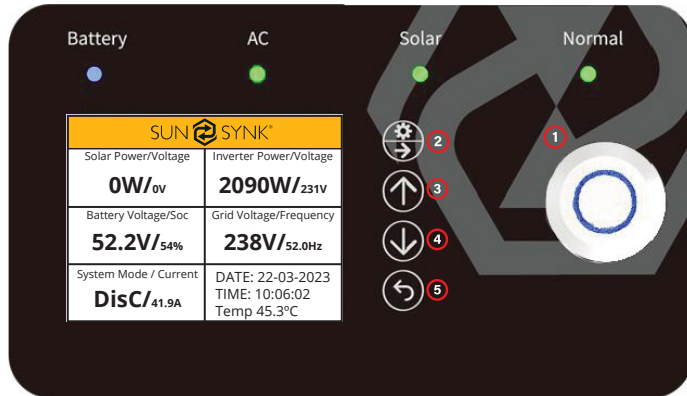

1. **Power** - to turn the system on / off.
2. **Settings / Select** - to operate the settings menu & to select.
3. **Up** - to navigate up.
4. **Down** - to navigate down.
5. **Home / Back** - to go back to the home menu & to navigate backwards.

TYPE	INDICATION	DESCRIPTION
BATTERY	GREEN	CHARGING
	BLUE	DISCHARGING
AC	GREEN	AC CONNECTED
	OFF	AC OFF
SOLAR	GREEN	SOLAR ON
	OFF	SOLAR OFF
NORMAL	GREEN	INVERTER RUNNING
	RED	SYSTEM FAULT
	OFF	INVERTER NOT RUNNING

7. FACTORY SETTINGS

Battery Settings		Default Setting		
Low Battery Cut Off		45.0V		
Reboot Voltage		50.0V		
Maximum Charge		40A		
Charge from MAIN		YES		
Float Charge Voltage		56.0V		
Active		ON		
System Configuration		Default Setting		
Maximum Discharge Current		70A		
Maximum Battery Voltage		56.0V		
Import Trickle Feed		0030W		
Export Control		Zero Export		
Earth Neutral Bond		Enable		
Night Power Saving		Enable		
Grid Settings		Default Setting		
Maximum Grid Voltage		253V		
Minimum Grid Voltage		195.5V		
Maximum Grid Frequency		52.0HZ		
Minimum Grid Frequency		47.5HZ		
System Controller			Default Setting	
00:00	6:00	2000W	52.0V	Y
6:00	12:00	2000W	52.0V	Y
12:00	18:00	2000W	52.0V	Y
18:00	23:59	2000W	52.0V	Y

8. OPERATION

8.1. System Flow

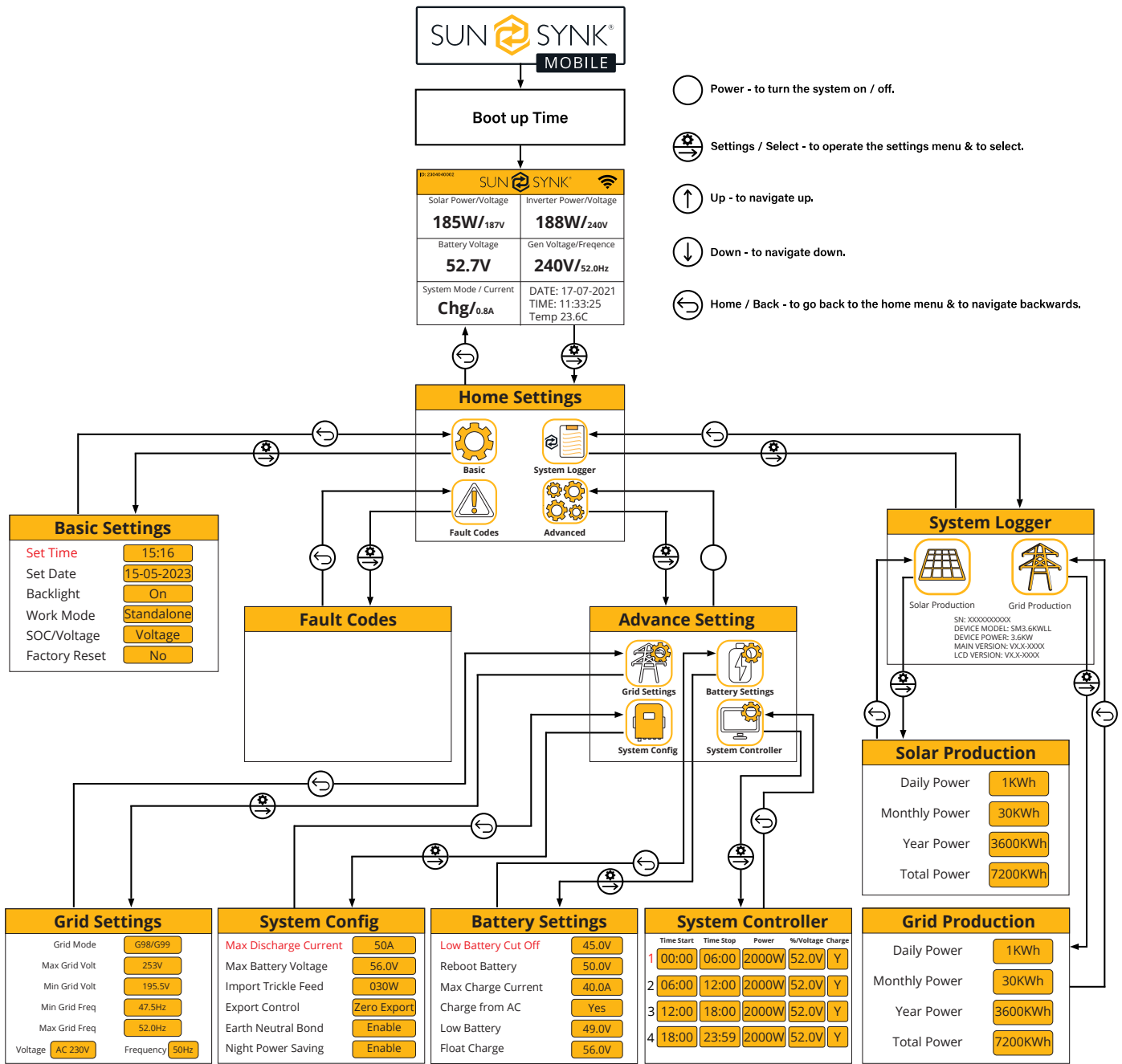

8.2. Switching On / Off

Once the inverter has been correctly installed and the batteries are connected, press the *on / off button* (located on the front of the case) to turn on the system.

8.3. Home Screen

SUN  SYNK®	
Solar Power/Voltage 0W/0V	Inverter Power/Voltage 2090W/231V
Battery Voltage/Soc 52.2V/54%	Grid Voltage/Frequency 238V/52.0Hz
System Mode / Current DisC/41.9A	DATE: 22-03-2023 TIME: 10:06:02 Temp 45.3°C

What does this page display?

Solar MPPT Input Power

Battery Voltage

System Status

Inverter Current Power

Grid Voltage and Frequency

Date / Time

What you can do from this page

If you press the select button you can navigate to the *basic setup menu*

If Sunsynk Connect has been connected, the WI-FI icon appears

Access the CT screen by pressing the Home/Back button

8.4. Home Settings

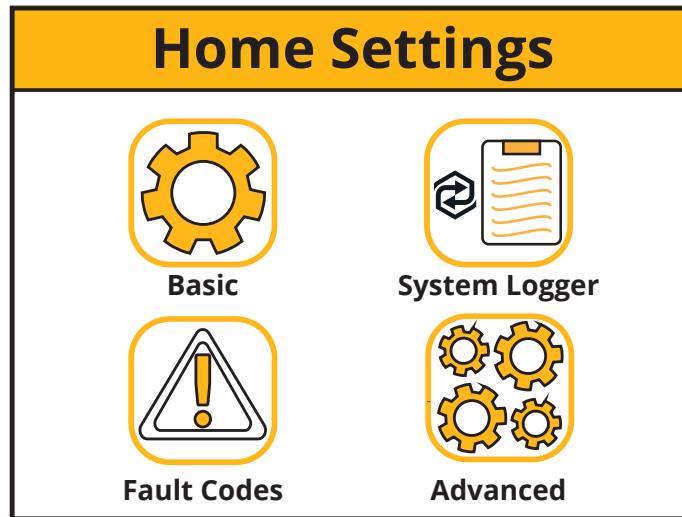

What does this page display?

Basic setting icon

System logger icon

Fault codes icon

Advanced settings icon

What you can do from this page

You can navigate through the functions by clicking on each icon

8.5. Basic Settings

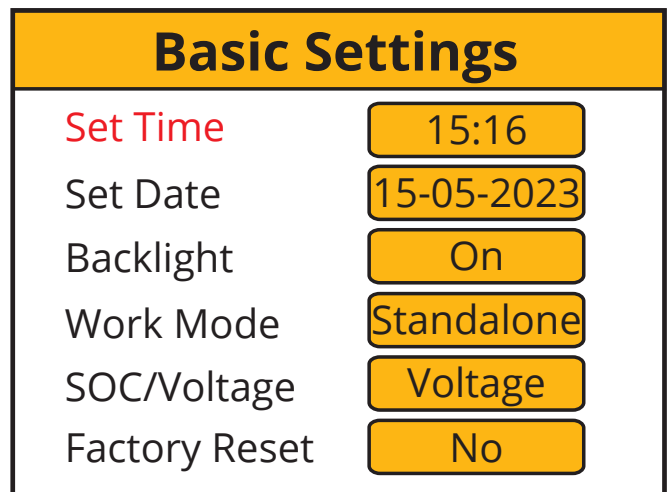
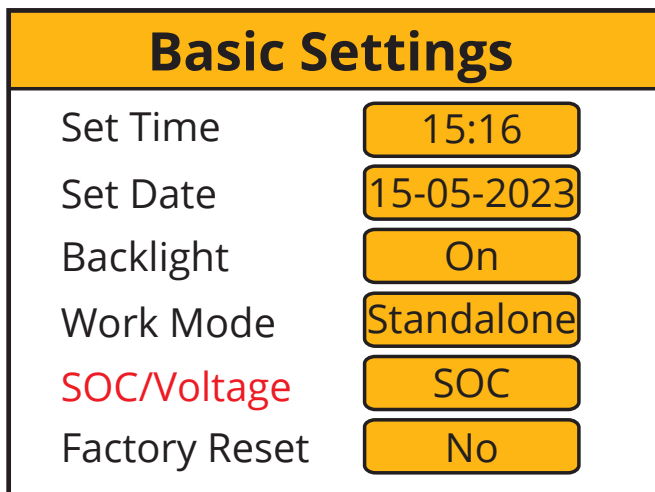

What does this page display?

Time

Date

Backlight on / off

Work Mode

SOC/Voltage

Reset

What you can do from this page

Set the system's time

Set the system's date

Set backlight

Set the workmode

Set the system SOC/Voltage

Reset to factory default settings

After changing the settings, do not forget to click *save settings*.

Basic Settings

Save Settings?

YES **NO**

8.6. Work Mode Settings

Change the work mode settings via the "Basic Settings" page by pressing the "Work Mode" button. Then a password input page will be shown. The default password is "1234".

Basic Settings

Set Time	15:16
Set Date	15-05-2023
Backlight	On
Work Mode	Standalone
SOC/Voltage	SOC
Factory Reset	No

SUN SYNK[®]

Please Input the Password

Then, the "Work Mode Settings" page will display.

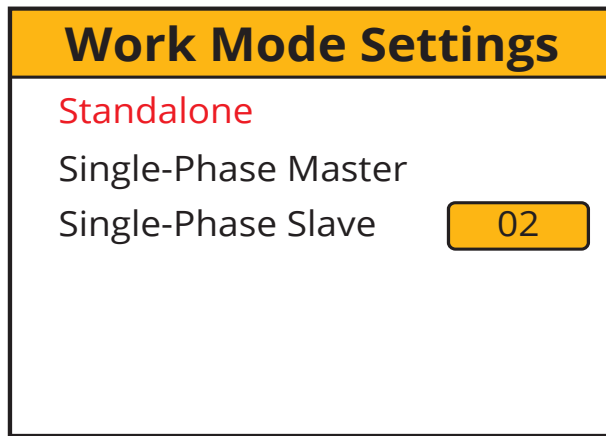

What does this page display?

The Work Mode selected

Single-Phase Master

Single-Phase Slave number

What you can do from this page

Change the number of Slave Inverters (maximum 15 slaves)

8.7. System Logger

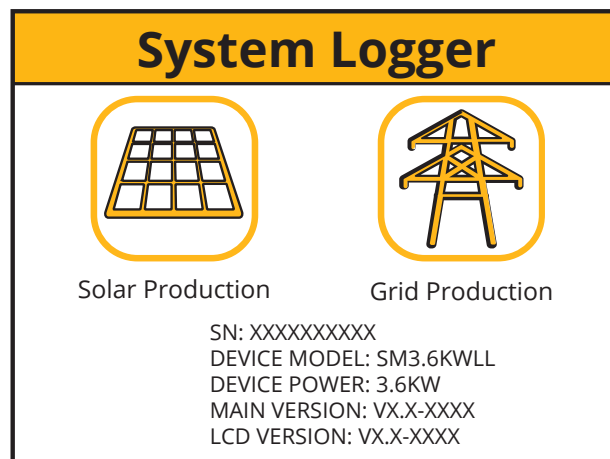

Solar Production	
Daily Power	1KWh
Monthly Power	30KWh
Year Power	3600KWh
Total Power	7200KWh

Grid Production	
Daily Power	1KWh
Monthly Power	30KWh
Year Power	3600KWh
Total Power	7200KWh

What does this page display?

Solar production icon

Grid production icon

What you can do from this page

Daily solar power produced

Monthly solar power produced

Yearly solar power produced

Total solar power produced

Daily grid power used

Monthly grid power used

Yearly grid power used

Total grid power produced

8.8. Advance Settings

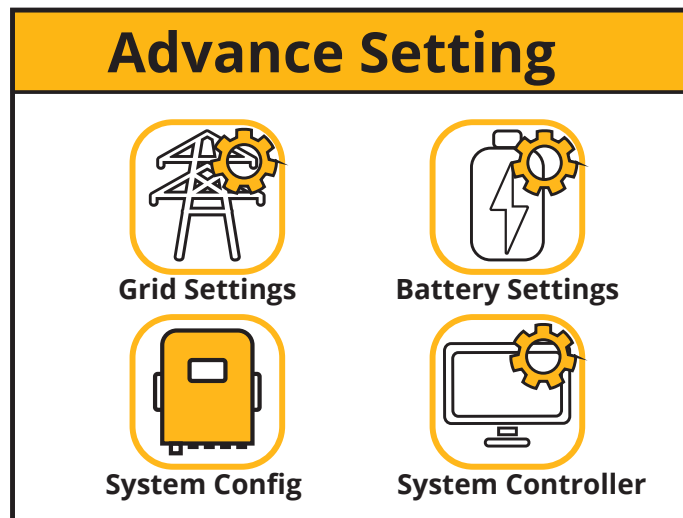

What does this page display?

Grid Settings page icon

System Configuration page icon

System Controller page icon

Battery Settings page icon

What you can do from this page

You can access the grid, system, inverter, and battery setting pages.

8.8.2. Grid Settings

Grid Settings	
Grid Mode	G98/G99
Max Grid Volt	253V
Min Grid Volt	195.5V
Min Grid Freq	47.5Hz
Max Grid Freq	52.0Hz
Voltage	AC 230V
Frequency	50Hz

What does this page display?

Grid Mode

Maximum grid voltage allowed

Minimum grid voltage allowed

Maximum grid frequency

Minimum grid frequency

8.8.1. Battery Settings

Battery Settings	
Low Battery Cut Off	10%
Reboot Battery	20%
Max Charge Current	40A
Charge from AC	Yes
Low Battery	15%
Float Charge	56.0V

Battery Settings	
Low Battery Cut Off	45.0V
Reboot Battery	50.0V
Max Charge Current	40.0A
Charge from AC	Yes
Low Battery	49.0V
Float Charge	56.0V

What does this page display?

Low battery SOC/Voltage

Reboot SOC/Voltage

Maximum charge current

Charge from the mains

Low Battery SOC/Voltage

Float charge SOC/Voltage

What you can do from this page

Set a *low voltage* cut-off for the batteries. Before setting this, please refer to the battery characteristics.

The *reboot voltage* is the voltage that the batteries must reach before the inverter switches on again.

Maximum charge is the maximum current that the system will provide to charge the batteries. This is normally rated at 0.5C, the battery's Ah (s) x 0.5. For example, if you have installed a 20Ah battery, then the maximum charge current should be set at 10A. The lower the setting, the longer the batteries will last.

If *charge from the mains* is set as *YES* the batteries will charge from the mains grid.

Float charge voltage must be set accordingly to the specifications of the battery used.

Set the Low Battery Voltage to set the point where Low power mode will take affect.

PLEASE NOTE

If the Charge from AC is set to No, the battery cannot be charged from AC GRID.

Otherwise, the battery can be charged from AC GRID.

8.8.3. System Settings

System Config	
Max Discharge Current	50A
Max Battery Voltage	56.0V
Import Trickle Feed	030W
Export Control	Zero Export
Earth Neutral Bond	Enable
Night Power Saving	Enable

What does this page display?

Maximum discharge current

Maximum battery voltage

Input power to prevent export

Export Control

Earth bonding

Night Power Shaving

What you can do from this page

Set the maximum discharge current from the batteries.

Set the maximum voltage the batteries should be charged to.

Set the "Import Trickle Feed" from GRID, minimum 20W.

Set the "Export Control". Could be "UPS" and "Zero Export".

If Earth Neutral Bond is enabled, the relay will make and earth neutral bond on the load port of the inverter after the grid power fails. This is for eath leakage devices to function correctly on this island circuit.

The Night Power Saving can be set to "Enable" or "Disable".

8.8.4. Export Control

The Export Control can be set as "UPS" and "Zero Export".

1. "UPS"

When the "Export Control" is set to "UPS", the inverter will not export power to the home load via the "GRID" connector, just power the essential load that is connected to the "LOAD" connector. When the "Charge from Main" is set to "Yes", the inverter can be charged from the main AC and PV, and the charge time period can be set via the "System Controller" page.

In the "System Controller" page, when the "charge" option is set to "N", the inverter will not be charged by the main AC from "Start Time" to "Stop Time" in this time period. When the "Charge" option is set to "Y", the inverter will be charged by the main AC from "Start Time" to "Stop Time" to "Vol" setting value in this time period.

2. "Zero Export"

When the "Export Control" is set to "Zero Export", the inverter will export power to the home load via the "GRID" connector and power the essential load that connected to the "LOAD" connector at the same time. The export power to the home load will not exceed the total power of the home load, so there is no exceeded power feed out, this is called "Zero Export". A CT (Limit) must be connected to the inverter in this work mode.

8.8.5. Charge From Main

The Charge from Main can be set to "Yes" or "No". When it is set to "Yes", the inverter can be charged by the main AC and PV. When it be set to "No", the inverter will just can be charged by PV, and can't be charged by the main AC.

Charge from AC

Yes

Charge from AC

No

When the "Charge from Main" is set to "Yes", the inverter can be charged from the main AC and PV, and the charge time period can be set via the "System Controller" page.

In the "System Controller" page, when the "charge" option is set to "N", the inverter will not be charged by the main AC from "Start Time" to "Stop Time" in this time period. When the "Charge" option is set to "Y", the inverter will be charged by the main AC from "Start Time" to "Stop Time" till to the "Vol" setting value in this time period.

8.8.6. Earth Neutral Bond

The Earth Neutral Bond can be set to "Enable" or "Disable". When is set to "Enable", this will provide the earth is connected to GRID earth when GRID has power. When it is set to "Disable", this function will not be available.

Earth Neutral Bond

Enable

Earth Neutral Bond

Disable

8.8.7. Night Power Saving

The Night Power Saving can be set to "Enable" or "Disable". When is set to "Enable", the Night Power Saving function will be available. When it is set to "Disable", this function will not be available.

PLEASE NOTE

"Night Power Saving" just can work when the "Charge from AC" is set to "No" and there is no PV power input.

The Night Power Saving working mode is described as follow:

1. First, you need set the "Low Battery Voltage" value at the "Battery Settings" page of the LCD display.
2. Then you need to set the "Night Power Saving" time periods and the value of "Vol" on the "System Controller" page.

There are 4 time periods, the inverter will discharge the battery till the battery voltage is equal to the value set at "Vol" section, if the values set are smaller than the value that set at "Low Battery Voltage", when the battery voltage is equal to this value of "Low Battery Voltage", then the inverter will stop its DC to DC converting, and the essential load connected to the "LOAD" connector will just be powered by the main AC. Because the most standby power consumption of the inverter is caused by the inverter's DC to DC converting, so when the inverter stops its DC to DC converting, the standby power of the inverter will be much lower, this can save a lot of power consumption.

PLEASE NOTE

Please remember that when the inverter is working on the "Night Power Saving" state, when the main AC is off, the UPS function shift time will be longer, can't be immediate, it will take around 30 seconds.

When there is PV power input, then the inverter's DC to DC converting will work again, because without this converting, the batter packs can't be charged.

8.9. Setting Details

1. UPS Mode

This mode function is set, the inverter output is from the load only and will not export any power to the GRID even if it is connected. Set the Charge from AC by "Yes" and Export Control set by "UPS".

Battery Settings	
Low Battery Cut Off	45.0V
Reboot Battery	50.0V
Max Charge Current	40.0A
Charge from AC	Yes
Low Battery	49.0V
Float Charge	56.0V

System Config	
Max Discharge Current	50A
Max Battery Voltage	56.0V
Import Trickle Feed	030W
Export Control	UPS
Earth Neutral Bond	Enable
Night Power Saving	Enable

Set the time to keep to charge the battery at the %voltage. If PV is not connected, suggest to set %voltage to 56V and set all time range to Y. Start to charge battery time by selecting the Charge Y or N

System Controller				
	Time Start	Time Stop	Power	%/Voltage Charge
1	00:00	06:00	1500W	100% Y
2	06:00	12:00	1500W	100% Y
3	12:00	18:00	1500W	100% Y
4	18:00	23:59	1500W	100% Y

2. Zero Export Mode

This mode function allows the inverter to export power to the home load via the "GRID" connector and power the essential load connected to the "LOAD" connector simultaneously. When zero export is ON, the inverter will export energy to the grid. The maximum power will not exceed the total load power of the grid.

Battery Settings	
Low Battery Cut Off	45.0V
Reboot Battery	50.0V
Max Charge Current	40.0A
Charge from AC	Yes
Low Battery	49.0V
Float Charge	56.0V

System Config	
Max Discharge Current	50A
Max Battery Voltage	56.0V
Import Trickle Feed	030W
Export Control	Zero Export
Earth Neutral Bond	Enable
Night Power Saving	Enable

System Controller					
	Time Start	Time Stop	Power	%/Voltage	Charge
1	00:00	06:00	2000W	52.0V	Y
2	06:00	12:00	2000W	52.0V	Y
3	12:00	18:00	2000W	52.0V	Y
4	18:00	23:59	2000W	52.0V	Y

3. Night Power Saving

When there is no PV, and the battery is not charged from AC, the output power will be to the load from the battery. When the battery level is equal to the battery set in the system control in that time period, and it is set to Y, then the inverter will run at a low power level from GRID to maintain the battery level is not dropped to shut down the inverter. The load power consumption will come from GRID. The setting will be as below.

Battery Settings	
Low Battery Cut Off	45.0V
Reboot Battery	50.0V
Max Charge Current	40.0A
Charge from AC	No
Low Battery	47.0V
Float Charge	56.0V

System Config	
Max Discharge Current	50A
Max Battery Voltage	56.0V
Import Trickle Feed	030W
Export Control	Export
Earth Neutral Bond	Enable
Night Power Saving	Enable

System Controller					
	Time Start	Time Stop	Power	%/Voltage	Charge
1	00:00	06:00	2000W	47V	Y
2	06:00	12:00	2000W	47V	Y
3	12:00	18:00	2000W	47V	Y
4	18:00	23:59	2000W	47V	Y

If the low battery voltage is set higher, the %voltage will be placed higher accordingly.

8.10. Fault Codes

To check fault codes, click on the *Fault Codes* icon on the *Home Settings* menu.

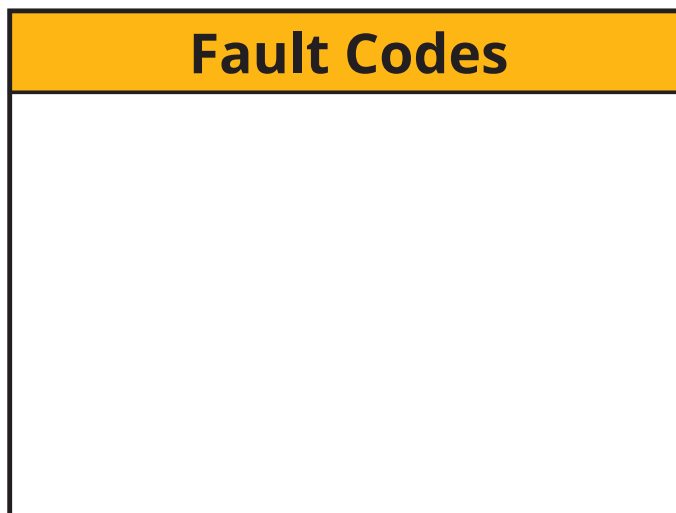

If any of the fault messages listed in the following table appear on your inverter and the fault has not been removed after restarting, please contact your local vendor or service centre. The following information is required:

1. Inverter serial number.
2. Distributor or service centre of the inverter.
3. On-grid power generation date.
4. The problem description (including the *fault code* and *indicator status* displayed on the LCD) is as detailed as possible.
5. Your contact information.

Error Code	Description	Solutions
F13	Working mode change	Inverter work mode changed: <ol style="list-style-type: none">1. Reset the inverter.2. Seek help from Sunsynk Mobile.
F15	Short circuit protecting	Short circuit fault: <ol style="list-style-type: none">1. Maintain the connection.2. Proceed to the settings to modify the work mode.3. Wait approximately 3-4 minutes.4. The device should return to its normal working condition, with the error cleared.5. Seek help from Sunsynk Mobile.
F18	AC over current fault or hardware	AC slide over current fault: <ol style="list-style-type: none">1. Check if the backup load power is within the range of the inverter.2. Restart and check if it is normal.
F20	DC over current fault of the hardware	DC over current fault: <ol style="list-style-type: none">1. Check PV module and battery connections.2. Reset the system.

Error Code	Description	Solutions
F23	AC leakage current is trans over current	Leakage current fault: <ol style="list-style-type: none"> 1. Check the PV module and inverter cables. 2. You may have a faulty PV panel (earth short). 3. Restart inverter.
F24	DC insulation impedance failure	PV isolation resistance is too low: <ol style="list-style-type: none"> 1. Check if the connection of PV panels and inverter are firmly connected. 2. Check if the earth bond cable on inverters is connected to the ground.
F26	The bus bar is unbalanced	<ol style="list-style-type: none"> 1. Please wait 5 minutes to see if it returns to normal. 2. Fully reset the inverter.
F29	ECAN communicate	<ol style="list-style-type: none"> 1. When in parallel mode, check the parallel communication cable connection and hybrid communication address settings. 2. During the parallel system startup period, inverters will report F29. When all inverters are in ON status, it will disappear automatically; 3. If the fault exists, please contact us for help.
F30	Load current exceeding	<ol style="list-style-type: none"> 1. Try to reduce the load power. 2. Seek help from Sunsynk Mobile.
F35	No AC grid	<ol style="list-style-type: none"> 1. Check if the inverter's connected to the <i>AC grid</i>. 2. Check if the RSCD had not tripped. 3. Check if the switch and fuses between the inverter and grid are all switched on.
F41	Parallel system stop	<ol style="list-style-type: none"> 1. Check the hybrid inverter working status. If there's 1pcs hybrid inverter is in OFF status, the other hybrid inverters may report F41 fault in parallel system. 2. If the fault exists, please contact us for help.
F42	AC line low voltage	Grid voltage fault: <ol style="list-style-type: none"> 1. Check if the voltage is in the range of standard voltage in specification, this can be adjusted via the grid set up page. 2. Check if grid cables are correctly connected.
F47	AC over frequency	Grid voltage fault: <ol style="list-style-type: none"> 1. Check if the voltage is in the range of standard voltage in specification, this can be adjusted via the grid set up page. 2. Check if grid cables are correctly connected.
F48	AC lower frequency	Grid frequency out of range: <ol style="list-style-type: none"> 1. Check if the frequency is in the range of specification. 2. You may need to adjust the frequency on the grid set up page.
F56	DC bus bar voltage is too low	Battery low voltage: <ol style="list-style-type: none"> 1. Check if the battery voltage is too low. 2. If the battery voltage is too low use the PV or grid to charge the battery. 3. Check the battery BMS. <p>Important: Especially with lithium batteries, ensure that the batteries Max. discharge current or power specification is the same or higher than the inverter specification.</p>

Error Code	Description	Solutions
F61	Bus one shutdown	<ol style="list-style-type: none"> 1. Reset the inverter. 2. Seek help from Sunsynk Mobile.
F63	FAN Error	<ol style="list-style-type: none"> 1. A technician needs to check the internal fan wire or replace fan. 2. Seek help from Sunsynk Mobile.
F64	Heat sink high-temperature failure	<p>Heat sink temperature is too high:</p> <ol style="list-style-type: none"> 1. Check if the working environment temperature is too high. 2. Turn off the inverter for 30 minutes and restart.

9. COMMISSIONING

9.1. Startup / Shutdown Procedure

The inverter must be installed by a qualified / licensed electrical engineer in accordance to the countries wiring regulations.

Only after the engineer has completed the *earth bond*, RCD and earth leakage tests, check the solar panel Voc voltage (must not exceed 450V) and check the battery voltage. Then, the inverter can now be switched on.

Power On Sequence:







1. Switch on the battery breaker.
2. Press the start button to on position.
3. Switch on AC.
4. Switch on the DC (PV isolator).

Shutdown Sequence:

1. Switch off the PV isolator.
2. Switch off AC.
3. Press the start button to off position.
4. Switch off the battery isolator.

9.2. Information for Commissioning the Inverter

After you have successfully powered up the inverter, the inverter must be programmed and set up as per the programming feature above.

	<p>Check the <i>earth bond</i> on the solar panels.</p>	<p>Check the Voc does not exceed 450V.</p>	<p>Ensure both MPPTs are balanced.</p>
	<p>Measure the supply voltage, check it matches the settings of the inverter.</p>	<p>If it falls out of the setting range it will cause the inverter to shut down and alarm.</p>	<p>See grid set up page.</p>
	<p>Check the battery charge and discharge is within the C rating of the battery. Too high will damage the battery.</p>		<p>Check the battery BMS is communicating with the inverter.</p>
	<p>This is the heart of the system, this controller everything.</p>	<p>Ensure you are familiar with this, if you fully understand the controller you will fully appreciate the capabilities of there inverter.</p>	
	<p>This is for paralleling systems and wind turbine.</p>	<p>If paralleling inverters in 3-phase, check you phase rotation before switching on the AC Load, in 3-phase the output voltage will increase across phase to 400V.</p>	<p>If using a wind turbine please ensure you have the correct limiting resistor, caps and rectifier.</p>
	<p>Familiarise yourself with common fault codes.</p>		

9.3. GFDI Fault

Before the inverter starts to connect to the grid, the inverter will first detect the impedance of PV + to ground, and the impedance of PV – to ground. If any of these impedance values is less than 33k, the inverter will not connect to the grid and will report an error F24 on its LCD.

10. MAINTENANCE

The inverter is low maintenance. However, it is important that at least twice a year (for dusty environments this may need to be carried out weekly) all the cooling fans and air ducts are cleaned and dust free.

Check if there are no fault codes and lithium battery communication is correct.

Weekly cleaning statement: suggest micromesh filters as an available option. Micro insects here are a real problem.

APPENDIX A

If an external residual current device (RCD) is used, a device of type (A / AC, etc) should be employed, with a tripping current of 30mA or higher.

Use of RCDs

Residual current devices (RCDs): An RCD dedicated for an IES may be used to meet the mechanical cable protection requirements and isolation requirements of BS 7671 for the cable from the switchboard to the IES. If an RCD is used, the RCD shall:

1. Disconnect all live conductors (including the actives and neutral).
2. Be of the type specified in the inverter manufacturer's instructions or as labelled on the inverter.

We recommend the use of an RCD on all circuits and sub circuits connected to the Sunsynk Mobile inverter. Residual current breaker with overcurrent protection (RCBO).

Earth-leakage protection class	Type A
Earth-leakage sensitivity	30mA
Curve code	C
Network type	AC
Poles description	2P
Earth-leakage protection time delay	Instantaneous

For more information, training videos, software upgrades, help line or forum please refer to <http://www.sunsynkmobile.com> - Tech Support (Do not forget to register first on the website).



CONTACT US

Email Us: sales@sunsynkmobile.com **Website:** www.sunsynkmobile.com

VAT Number: 175669460

Address UK: Sunsynk UK Ltd. 17 Turnstone Business Park,
Mulberry Avenue, Widnes, Cheshire, WA8 0WN

Call Us UK: +44 151 832 4300